



ENTRUST

Cleaning Guide

**Entrust Artista® CR8xx and
RSx Retransfer Card Printer**

**Entrust Artista® CR825,
CE875 and RS4 Instant
Financial Issuance System**

Contents

Cleaning Kit Contents	3
Cleaning Schedule	4
Routine Printer Cleaning	4
Additional Cleaning Tasks.....	5
Before You Begin	6
Use the Isopropanol Cleaning Card	7
Single-Hopper Printer	7
Multi-Hopper Printer	8
Run the Isopropanol Cleaning Card (CRxx and CE875 LCD Panel).....	9
Run the Isopropanol Cleaning Card (RSx LCD Panel).....	10
Run the Isopropanol Cleaning Card (cont.)	11
Use the Adhesive Cleaning Card	12
Single-Hopper Printer	12
Multi-Hopper Printer	13
Run the Adhesive Cleaning Card (CR8xx and CE875 LCD Panel)	15
Run the Adhesive Cleaning Card (RSx LCD Panel)	16
Prepare the Printer After Using a Cleaning Card.....	17
Replace the Cleaning Sleeve	18
Clean the Printhead.....	20
Clean the Printhead Cam Rollers.....	24
Clean the Rear Fan Filter.....	25
Card Handling Information	26

Cleaning Kit Contents

The cleaning kit (part number 524554-001) contains the supplies necessary to clean the printer and maintain print quality. The cleaning kit contains the following items:

Cleaning Supply	Part Number
Cleaning Sleeves, 5 pack	569946-001
Cleaning Swabs, 5 pack	507377-001
Isopropanol Cleaning Cards, 10 pack	552141-002
Adhesive Cleaning Cards, 10 pack	524405-001
2 Lapping Sticks	510108-001 or 529233-001
Lapping Stick Support  Retain the support tool for future cleaning use.	529107-001 or 529147-001
Card Inspection Gloves, 12 pairs/pack	812335-001

Refer to the [“Cleaning Schedule” on page 4](#) for a complete schedule of when to use the cleaning kit items.

For complete information about how to use and maintain the printer, refer to your printer’s *User’s Guide*.

Artista Retransfer Printer

Cleaning Schedule

Cleaning the retransfer series printer on a regular schedule helps to maintain the printer and obtain the best print quality

Routine Printer Cleaning

The following table describes the recommended routine cleaning tasks for the printer.

Schedule	Action	Procedure
Each time you change the ink ribbon	Clean the printer with the isopropanol cleaning card.	<ul style="list-style-type: none">• “Single-Hopper Printer” on page 7• “Multi-Hopper Printer” on page 8
	Replace the cleaning sleeve (C3).	“Replace the Cleaning Sleeve” on page 18
	Clean the printhead	“Clean the Printhead” on page 20
Every 3 months	Clean the rear fan filter (if present).	Note: The rear fan filter is not present in all printer models. If the filter is present, refer to “Clean the Rear Fan Filter” on page 25 .

In addition to these routine cleaning tasks, you may need to perform additional cleaning procedures if the print quality diminishes. Refer to [“Additional Cleaning Tasks” on page 5](#).

Additional Cleaning Tasks

The following table describes additional cleaning tasks you may need to perform to maintain your printer and print quality. Do these procedures, in addition to the routine cleaning, if you experience printing issues.

Schedule	Action	Procedure
If you see particles on completed cards	Replace the cleaning sleeve (C3).	“Replace the Cleaning Sleeve” on page 18
	Clean the printer with the adhesive cleaning card.	<ul style="list-style-type: none">• “Single-Hopper Printer” on page 12• “Multi-Hopper Printer” on page 13
If you see color or white lines on completed cards	Clean the printhead	“Clean the Printhead” on page 20
If you see repeating color dots on completed cards	Clean the printhead cam rollers.	“Clean the Printhead Cam Rollers” on page 24



The type of card stock you use and the printer environment can affect how often you need to perform the cleaning procedures.

Refer to [“Card Handling Information” on page 26](#) for suggestions to help manage your card stock.

Artista Retransfer Printer

Before You Begin

- If your printer has locks, unlock the input hopper or printer access door lock. If your printer does not have locks, disregard any instructions that ask you to unlock the printer.
- When you clean the printer using either the isopropanol or adhesive cleaning card, remove the ink ribbon (C1) and retransfer film (C2) cartridges, and the cleaning sleeve (C3).
- Some procedures require you to remove only one of the cartridges. Refer to the instructions for complete information.

Do the following to prepare the printer for cleaning, as directed by the cleaning instructions.

1. Unlock the printer and open the printer access door.
2. Remove the ink ribbon and retransfer film cartridges.

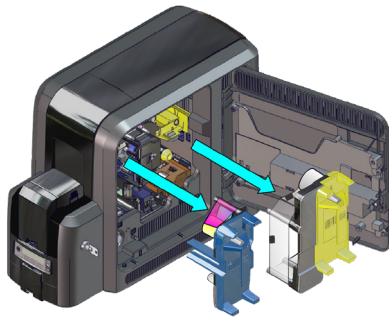

3. Remove the cleaning sleeve (C3) from the printer.

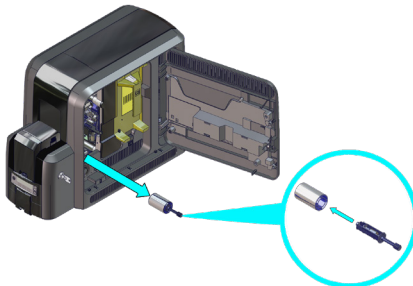

4. Close and lock the printer access door, unless instructed otherwise.
5. Continue with the cleaning procedure.

Use the Isopropanol Cleaning Card

Clean the printer with the isopropanol cleaning card each time you change the ink ribbon, or more often if necessary.

Single-Hopper Printer

1. Remove the ink ribbon and retransfer film cartridges, and the cleaning sleeve. Refer to [“Before You Begin”](#) on page 6.
2. Unlock and open the input hopper.
3. Remove the unprinted cards. Handle the cards by the edges or wear card inspection gloves.

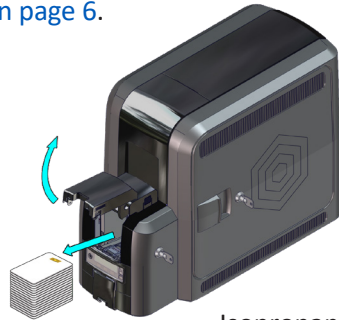

4. Open the cleaning card package and remove the isopropanol cleaning card.



5. Load the cleaning card in the input hopper. Clean the printer immediately. The cleaning card dries out if it is out of its package for more than a few minutes.

If the cleaning card appears bowed, insert it as shown.

Card Without Bow



Card With Bow

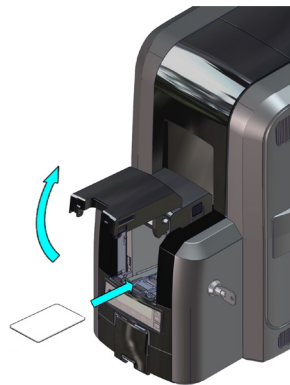

6. Close the input hopper and lock the printer.
7. Continue with [“Run the Isopropanol Cleaning Card”](#) on page 10.

Artista Retransfer Printer

Multi-Hopper Printer

1. Remove the ink ribbon and retransfer film cartridges, and the cleaning sleeve. Refer to “Before You Begin” on page 6.
2. Open the cleaning card package and remove the isopropanol cleaning card.

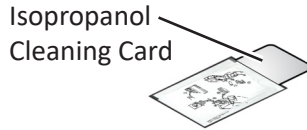

3. Pull out the multi-hopper exception slide and insert the cleaning card.
4. Push in the exception slide. Clean the printer immediately. The cleaning card dries out if it is out of its package for more than a few minutes.

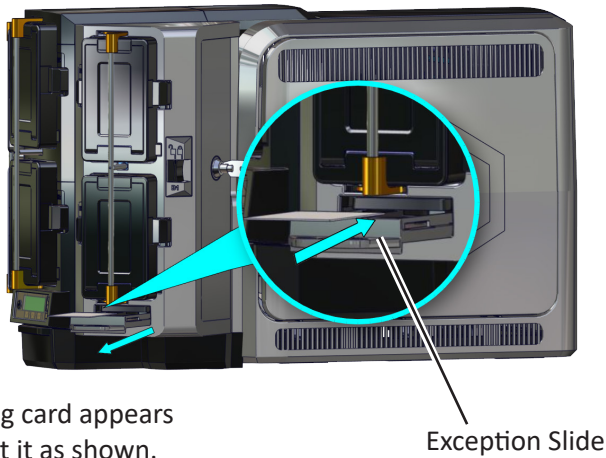

If the cleaning card appears bowed, insert it as shown.

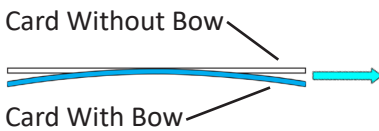

5. Continue with “Run the Isopropanol Cleaning Card” on page 10.

Run the Isopropanol Cleaning Card (CRxx and CE875 LCD Panel)

1. Use the LCD panel to run the isopropanol cleaning card.

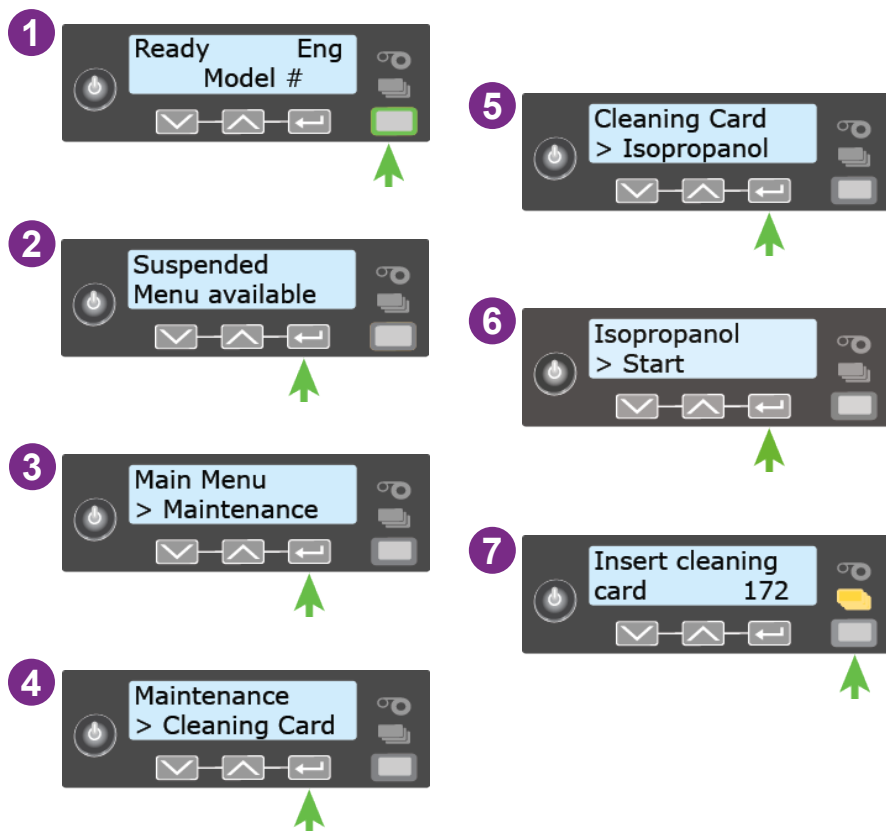

When the cleaning cycle completes:

- **If the printer does not have locks:** The isopropanol cleaning card is ejected into the output hopper. Retrieve and save the cleaning card to clean the upper ribbon guide.
- **If the printer has locks:** The isopropanol cleaning card is placed in the printer reject tray (RT1). Retrieve and save the cleaning card to clean the upper ribbon guide.

Artista Retransfer Printer

Run the Isopropanol Cleaning Card (RSx LCD Panel)

1. Use the LCD panel to run the isopropanol cleaning card.

1

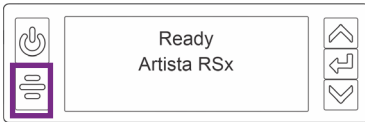

2

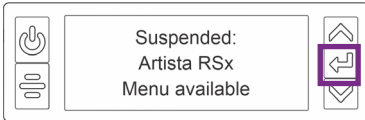

3

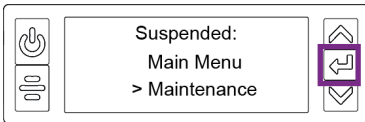

4

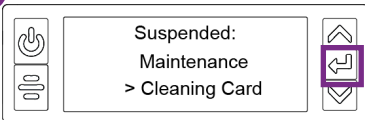

5

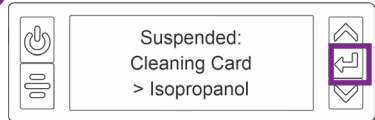

6

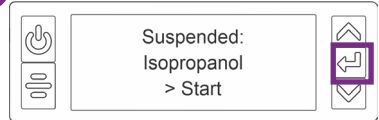

7

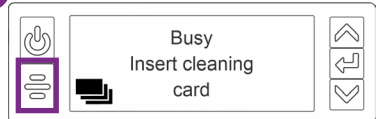

When the cleaning cycle completes:

- **If the printer does not have locks:** The isopropanol cleaning card is ejected into the output hopper. Retrieve and save the cleaning card to clean the upper ribbon guide.
- **If the printer has locks:** The isopropanol cleaning card is placed in the printer reject tray (RT1). Retrieve and save the cleaning card to clean the upper ribbon guide.

Run the Isopropanol Cleaning Card (cont.)

2. After the cleaning card is used to clean the printer, reuse it to wipe debris from the upper ribbon guide post on the ribbon cartridge.

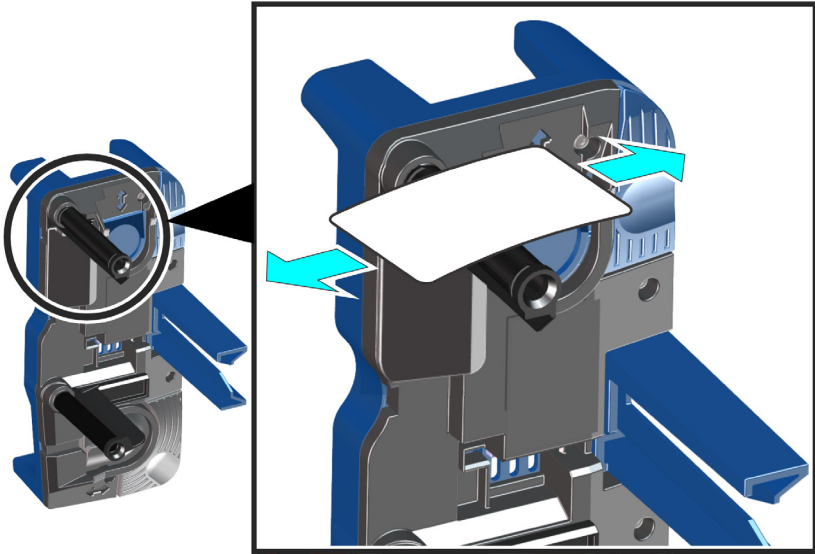

3. Continue with [“Prepare the Printer After Using a Cleaning Card”](#) on page 17.

Artista Retransfer Printer

Use the Adhesive Cleaning Card

Use the adhesive cleaning card to remove particles that result from the retransfer process. Refer to [“Additional Cleaning Tasks” on page 5](#) for information about when to use the adhesive cleaning card.

Single-Hopper Printer

1. Remove the ink ribbon and retransfer film cartridges, and the cleaning sleeve. Refer to [“Before You Begin” on page 6](#).
2. Unlock and open the input hopper.
3. Remove the unprinted cards. Handle the cards by the edges or wear card inspection gloves.

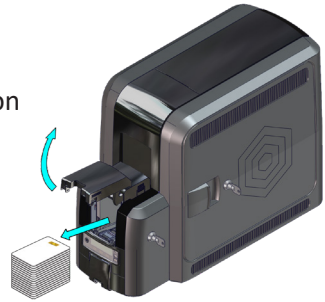

4. Peel off the center strips on both sides of the adhesive cleaning card. Leave the side strips in place.

Peel Off Center Strips Only

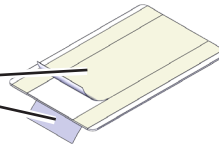

5. Load the adhesive cleaning card in the input hopper.

If the cleaning card appears bowed, insert it as shown.

Card Without Bow



Card With Bow

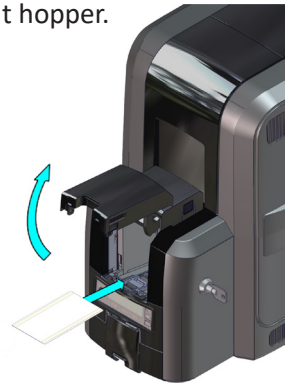

6. Close and lock the input hopper.
7. Continue with [“Run the Adhesive Cleaning Card” on page 15](#).

Multi-Hopper Printer

1. Remove the ink ribbon and retransfer film cartridges, and the cleaning sleeve. Refer to “Before You Begin” on page 6.
2. Unlock the multi-hopper.
 - a. Unlock the multi-hopper door lock (a).
 - b. Slide the lock bar release button (B1) to the left to release the hopper lock bars (b).
 - c. Rotate the center lock bar to the left to provide access to the H2 and H5 multi-hopper input cartridges (c).

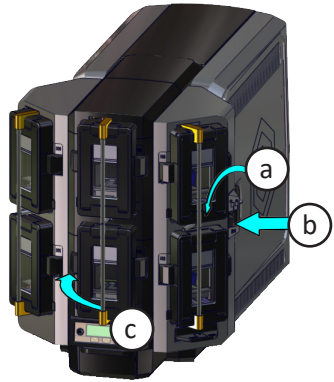

3. Press the cartridge release button at the top of the H2 cartridge and open the cartridge door (d).
4. Lift the card weight to the top of the cartridge and gently pull it forward until it locks in position (e).
5. Remove the unprinted cards from the H2 cartridge (f). Handle the cards by the edges or wear card inspection gloves.

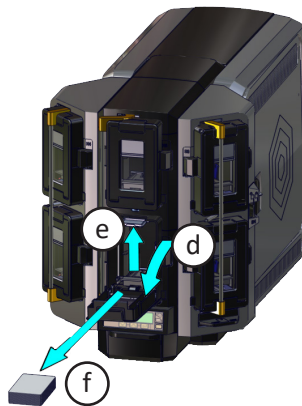

Artista Retransfer Printer

Multi-Hopper Printer (cont.)

6. Peel off the center strips on both sides of the adhesive cleaning card. Leave the side strips in place.

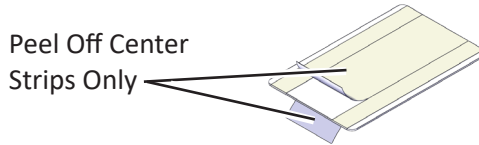

7. Load the adhesive cleaning card in the H2 cartridge and close the cartridge door (g).

If the cleaning card appears bowed, insert it as shown.

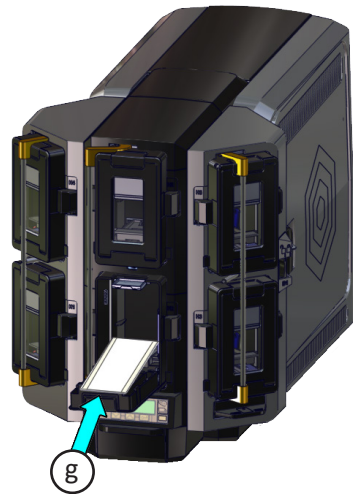
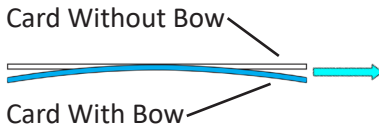

Do not insert the adhesive cleaning card in the exception slide of the multi-hopper.

8. Lock the multi-hopper.
 - a. Rotate the center lock bar to the right to the lock position.
 - b. Slide the lock bar release button to the right to lock the lock bars into place.
 - c. Lock the multi-hopper door lock.
9. Continue with [“Run the Adhesive Cleaning Card”](#) on page 15.

Run the Adhesive Cleaning Card (CR8xx and CE875 LCD Panel)

1. Use the LCD panel to run the adhesive cleaning card.

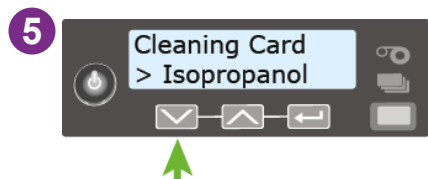
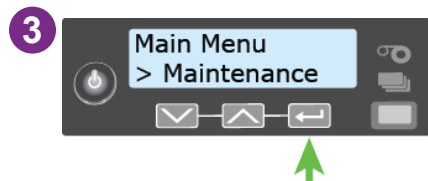
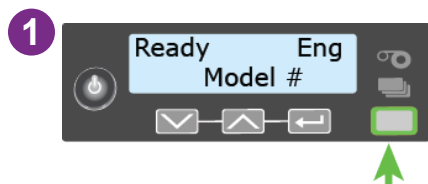

If you are cleaning a single-hopper printer, the following message displays.

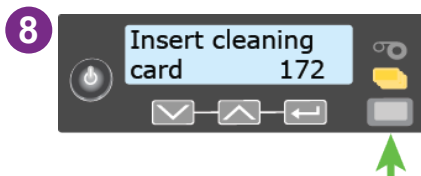

OR

If you are cleaning a multi-hopper printer, the following message displays.

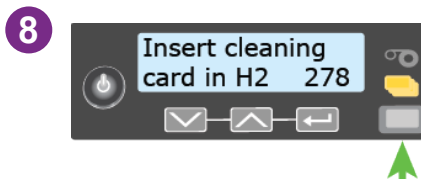

When the cleaning cycle completes, the adhesive cleaning card is ejected into the printer reject tray (RT1).

2. Continue with [“Prepare the Printer After Using a Cleaning Card”](#) on page 17.

Artista Retransfer Printer

Run the Adhesive Cleaning Card (RSx LCD Panel)

1. Use the LCD panel to run the adhesive cleaning card.

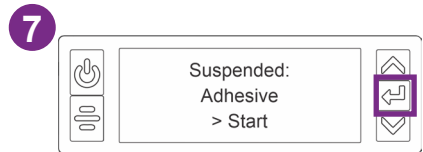
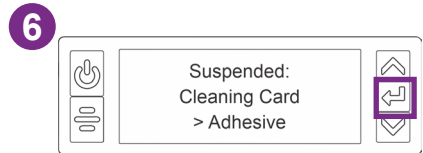
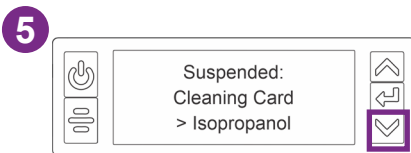
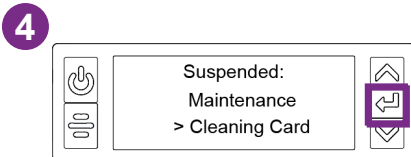
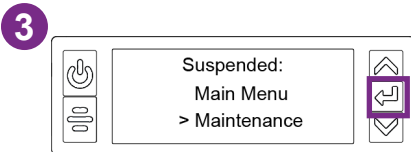
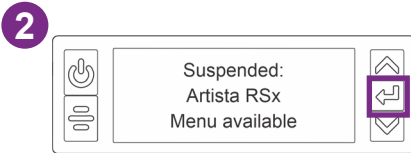
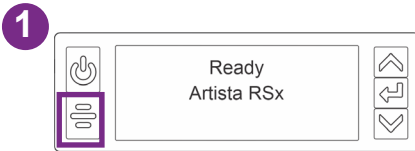

If you are cleaning a single-hopper printer, the following message displays.

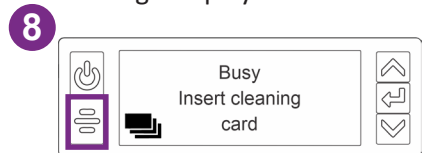

OR

If you are cleaning a multi-hopper printer, the following message displays.

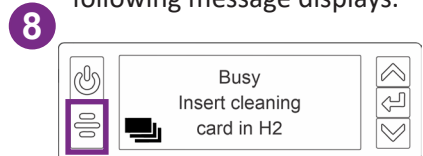

When the cleaning cycle completes, the adhesive cleaning card is ejected into the printer reject tray (RT1).

2. Continue with [“Prepare the Printer After Using a Cleaning Card”](#) on page 17.

Prepare the Printer After Using a Cleaning Card

Do the following after the cleaning cycle completes.

1. Remove the used cleaning card.
 - a. Unlock the printer and open the printer access door.
 - b. Remove the used cleaning card from the printer reject tray (RT1).
 - c. Discard the cleaning card.
2. Install a new cleaning sleeve. Refer to [“Replace the Cleaning Sleeve” on page 18](#).
3. Install the ink ribbon and retransfer film.
 - a. Load new ink ribbon and retransfer film on the cartridges. Refer to the printer’s *User’s Guide* for complete instructions.
 - b. Replace the cartridges in the printer.
 - c. Close and lock the printer access door.
4. Replace the cards in the printer.
 - a. Unlock the input hopper lock.
 - b. Place the cards in the input hopper of a single-hopper printer, or the H2 cartridge of a multi-hopper printer.
 - c. Close the input hopper and lock the input hopper lock.

Replace the Cleaning Sleeve

The cleaning sleeve removes dust and other particles from cards before they move into the printer. Replace the cleaning sleeve each time you change the ink ribbon. Refer to the [“Cleaning Schedule” on page 4](#) for additional information.

1. Remove the ink ribbon (C1) cartridge from the printer (refer to [“Before You Begin” on page 6](#)).
2. Lift up the cleaning spindle handle (C3) and pull it straight out from the printer.
3. Remove the used cleaning sleeve from the cleaning spindle and discard it.

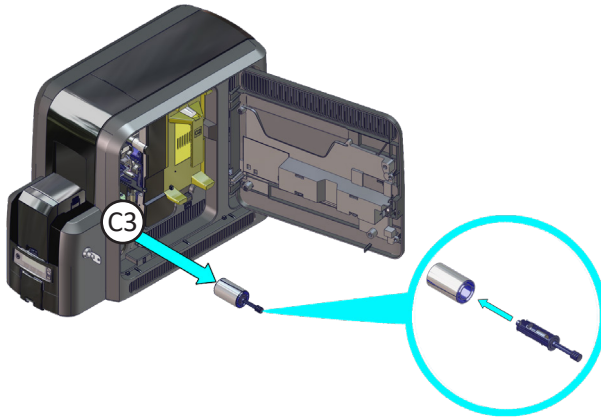

4. Slide the new cleaning sleeve onto the cleaning spindle.

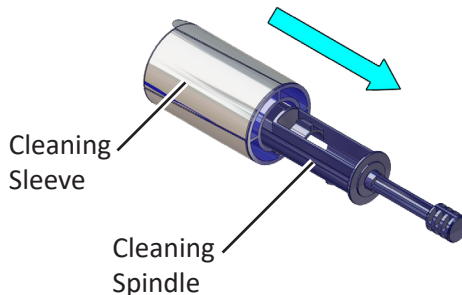

Replace the Cleaning Sleeve (cont.)

5. Remove the protective wrapper from the cleaning sleeve and discard it.

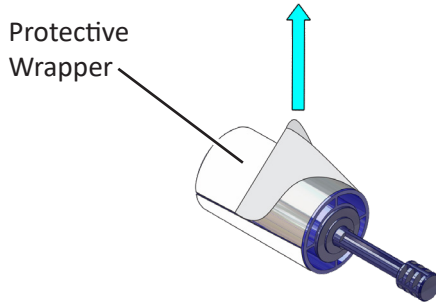

6. Replace the cleaning spindle in the C3 slot in the printer.

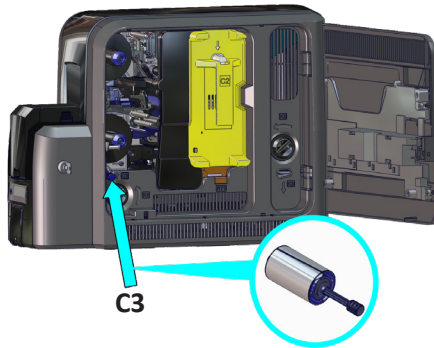

7. Replace the ink ribbon cartridge in the printer and close and lock the printer access door.

Artista Retransfer Printer

Clean the Printhead

Clean the printhead each time you change the ink ribbon, or if you notice print quality issues on cards. Refer to the [“Cleaning Schedule” on page 4](#) for printhead cleaning recommendations.

Use the following items to clean the printhead.

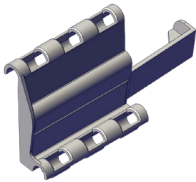

Lapping Stick Support

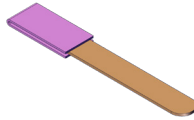

Lapping Stick



Cleaning Swab

The lapping stick support may be stored on the inside of the printer access door.

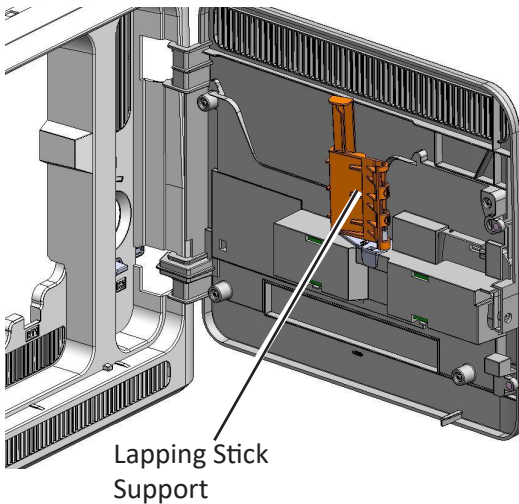

Lapping Stick Support

Clean the Printhead (cont.)

1. Prepare the printer.
 - a. Power off the printer.
 - b. Remove the ink ribbon (C1) and retransfer film (C2) cartridges from the printer (refer to [“Before You Begin”](#) on page 6).
2. Insert the lapping stick support into the printer. The support tool fits over the cartridge guideposts and slides into the printer.

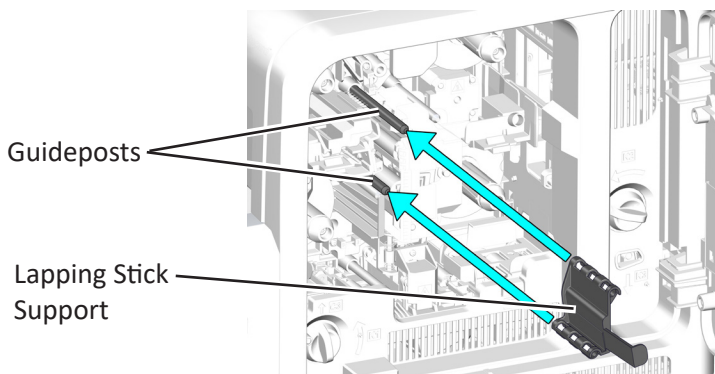

Artista Retransfer Printer

Clean the Printhead (cont.)

3. Clean the printhead with the lapping stick.



Do not remove the pink lapping paper from the lapping stick.

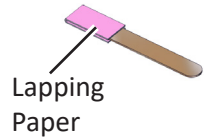

- a. Insert the lapping stick into the lower portion of the support tool. Slide it in until it stops.

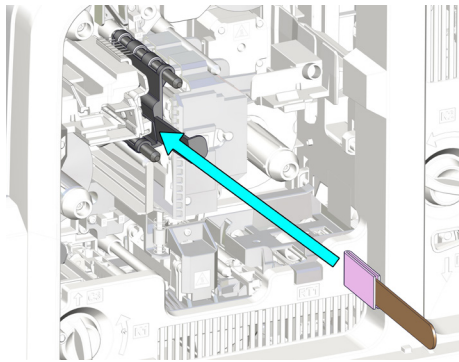

- b. Move the lapping stick back and forth 3 times to clean the printhead.

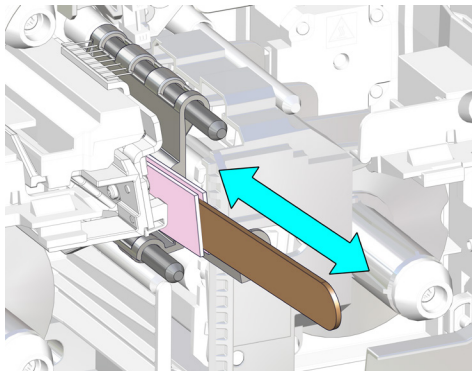

- c. Remove the lapping stick from the support tool.



You can use the lapping stick twice, one cleaning per side. Store the lapping stick after the first use.

Clean the Printhead (cont.)

4. Clean the printhead with the cleaning swab.
 - a. Open the cleaning swab package.
 - b. Insert the cleaning swab into the support tool. Center the swab as shown in the illustration (or toward the top of the support tool handle).

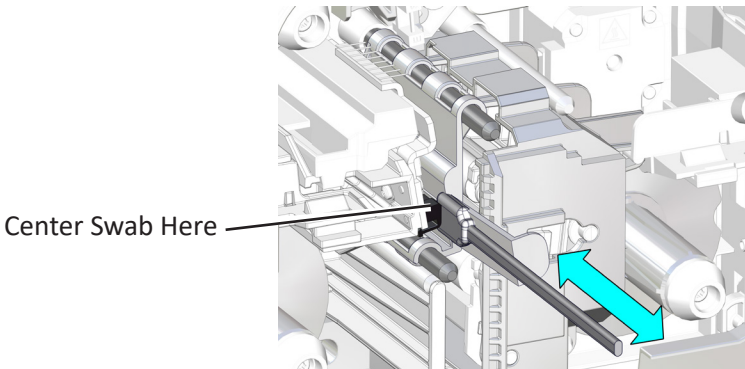

- c. Move the cleaning swab back and forth 3 times to remove any remaining debris from the printhead area.
 - d. Remove the cleaning swab from the support tool.
5. Remove the support tool from the printer.
 -  Do not discard the lapping stick support tool. Retain it for future cleaning use.
6. Replace the ink ribbon and retransfer film cartridges and close the printer access door.
7. Power on the printer.
8. Print one or more test cards to verify the print quality.

HINTS & TIPS

- Use only the lapping stick and cleaning swab to clean the printhead. Other materials can stick to the printhead and cause damage.
- Discard the lapping stick after the second use.
- Use the cleaning swab one time only. Discard the swab after cleaning the printhead.

Clean the Printhead Cam Rollers

Use the adhesive cleaning card to clean the printhead cam rollers.

1. Power off the printer.
2. Remove the retransfer film (C2) cartridge from the printer (refer to [“Before You Begin”](#) on page 6).
3. Peel off the center and both side strips from one side of the adhesive cleaning card.

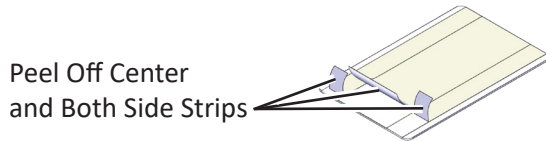

4. Insert the cleaning card into the printer between the retransfer cartridge guidepost and the rollers. Make sure that the adhesive side of the card faces to the right and touches the rollers.
5. Move the cleaning card up and down along the rollers to remove any debris.

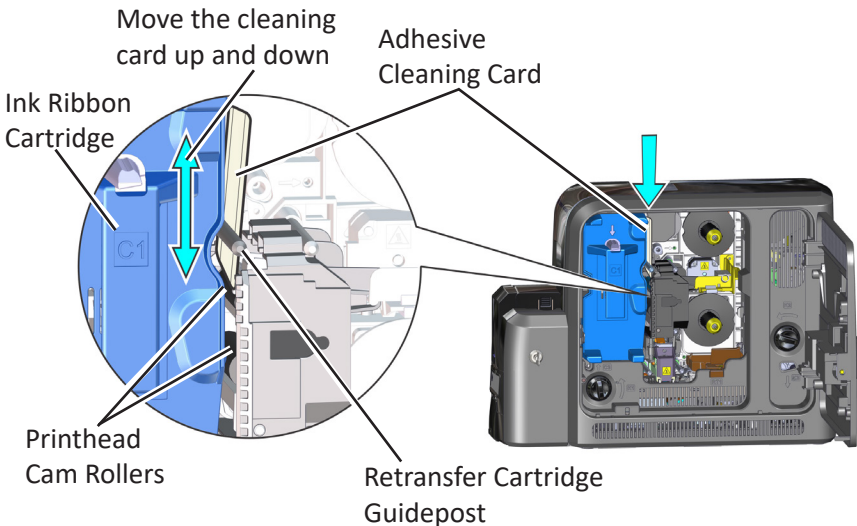

6. Replace the retransfer film cartridge. Close and lock the access door and restart the printer.
7. Discard the used cleaning card.

Clean the Rear Fan Filter



The rear fan filter is not present in all printer models.

If your printer includes a rear fan filter, clean the filter every three months.

1. Unlock the printer and open the printer access door.
2. Press the K3 rear access door release to open the rear access door.
3. Lift up and remove the filter from the fan mount.



4. Rinse the filter under running water and shake it gently to remove excess liquid. Pat it with a paper towel to remove additional water.
5. Allow the filter to dry completely.
6. Insert the filter into the fan mount.
7. Close the rear access door.
8. Close the printer access door and lock the printer.

Card Handling Information

Use the following information when purchasing and handling card stock:

- Purchase quality card stock. Excessive burrs, scratches, surface defects, or contaminants on cards can result in print errors.
- Grease or oils, such as oils from your fingers, can reduce card quality. To keep cards completely clean, do not touch the print surface of a card.
- Handle blank card stock by the edges only, or wear the card inspection gloves included in the cleaning kit.
- Debris or particles on blank card stock can reduce card quality and damage the system. If you drop a card on the floor, clean it using a lint-free cloth before using it in the system. Do not use solvents to clean the card.
- Avoid contact with the following, as they can cause discoloration or fading of the cards:
 - Organic solvents, such as alcohol, film cleaner, or diazo paper.
 - Soft vinyl chlorides, document cases, pass holders, or erasers.
 - Hand lotions, hairdressing products, or cosmetics.
- Avoid storing the cards in locations exposed to direct sunlight, or with high temperature and high humidity.

Notes



ENTRUST

1187 Park Place

Minneapolis, Minnesota 55379

952.933.1223 • 952.933.7971 Fax

www.entrust.com

Entrust, Sigma and the hexagon design are trademarks, registered trademarks and/or service marks of the Entrust Corporation in the United States and other countries. Datacard is a registered trademark and service mark of Entrust Corporation in the United States and other countries. All other trademarks are the property of their respective owners.

© 2019 - 2024. The design and information contained in these materials is protected